



Full-Track®
We'll put you right on track!!

OPERATION & MAINTENANCE
MANUAL



HSH



Robin
SUBARU



HONDA
ENGINES

FT-448









Full-Track®
We'll put you right on track!!

WALK-BEHIND TROWEL MACHINE

SAFETY PRECAUTIONS

	<p>⚠ DANGER EXPLOSION HAZARD Never operate the machine in an explosive atmosphere, near combustible materials or where ventilation does not clear exhaust fumes.</p>		<p>⚠ CAUTION ROTATING HAZARD Never place hands or feet inside safety guard rings. Serious injury will result from contact with rotating blades.</p>		<p>⚠ ATTENTION READ OWNERS MANUAL Read and understand operator's manual before using this machine. Failure to follow operating instructions could result in serious injury or death.</p>
	<p>⚠ WARNING BURN HAZARD Never come into contact with the engine or muffler when engine is operating or shortly after it is turned off. Serious burns may occur.</p>		<p>⚠ CAUTION MOVING PARTS Before starting the machine ensure that all guards and safety devices are in place and functioning properly.</p>		



Congratulations for acquiring this fantastic Full-Track Trowel Machine.

This machine is manufactured with best industrial materials and quality craftsmanship presently available.

This manual contains important information for both operating and maintenance of this machine. In order to achieve safe and optimum performance of your trowel machine, please read this manual thoroughly prior to operating your machine.

**** Please keep this manual for future reference. ****

The manufacturer reserves the right to change the contents of this manual at any time without advance notice in order to improve the quality and performance of the machine. If you have any technical questions about this machine, please contact the manufacturer.



Caution !!!

Please pay extra attention to the SAFETY sections of this manual.

Important Notes

The gas engine operation manual is a part of this document.
Please refer to the engine manual for proper operation and maintenance of the engine.



INDEX

	Pg.		Pg.
1. Introduction-----	4	13. Routine Checks-----	12
2. Safety-----	5	13.1 Daily Check	
2.1 Operational Safety		13.2 Weekly Check	
2.2 Maintenance Safety		14. Machine Parts Replacement-----	13
3. Prior to Starting the Engine-----	6	14.1 Changing Blades	
4. Starting the Trowel-----	7	14.2 Changing V-Belts	
5. Control of the Trowel Motions-----	7	14.3 Changing the Gearbox Oil	
6. Stopping the Engine-----	8	15. Ordering Spare Parts-----	15
7. First Time Operator-----	8	16. Troubleshooting-----	16
8. Rough Concrete Surface-----	8	17. Technical Data-----	17
9. General Use-----	9	18. Appendix I-----	18
9.1 Floating Operation		Floating & Finishing Concrete	
9.2 Finishing Operation		19. Appendix II-----	25
10. Cleaning the Machine-----	10	FT-432 Exploded Drawings	
11. Transporting the Machine-----	10		
12. Obtaining Better Performance and Reliability for Your Machine-----	11		



1. INTRODUCTION

Specific Use

The machine described in this manual is powered by a gas engine via a pair of centrifugal variable speed clutches. These clutches drive four blades specifically designed for effective and smooth finishing for concrete; epoxy floors & sub-floors only.

**** It should not be used for any other purposes other than specified. ****



2. SAFETY

Consider Safety At All Time!

Read this manual thoroughly for safer and better operation of Full-Track trowel machine.

2.1 Operational Safety

- This machine should be operated by an expert or trained personnel only.
- Do not run this machine until all safety and guarding devices are in place.
- Ensure proper working environment before starting the engine.
- Keep the body; hands & feet clear from the guard rings.
- Use appropriate working equipment, including but not limited to, proper working clothing and Steel-Toed Working Boots. Avoid wearing loose clothing or accessories such as necklaces or bracelets.
- Never leave the machine unattended while engine is running.
- Always pay extra caution to flammable liquids. Refueling engine should only be allowed with a fully stopped and cooled engine in a well ventilated area away from any sparks and/or flames.
- Never smoke around or near the machine.
- Never operate the machine in confined; none-ventilated areas due to the carbon dioxide and monoxide emissions from the engine exhaust.



2.2 Maintenance Safety

- Be sure that engine switch is set at “OFF” position to prevent engine from accidentally starting.
- Never smoke around or near the machine while servicing.
- Do not perform any service work on a running machine. Shut off and cool down the machine before any servicing.
- Keep machine in proper running condition at all times.
- Replace any damaged or broken parts immediately.

3. PRIOR TO STARTING THE ENGINE

Always check the following items before starting the engine:

- Check engine oil level and refill to the recommended levels if necessary. Use only oil recommended by the engine manufacturer. (Refer to your engine manual).
- Check fuel level and top off if necessary. Use only pure, recommended fuel by engine manufacturer. Fuel must be free from any water; debris and foreign materials.



4. STARTING THE TROWEL

Prior to starting the trowel machine, make certain that both the engine and centrifugal safety switches are at “ON” position. Ensure that the throttle is at idle position (forward position). Open the fuel valve. Adjust choke according to environmental temperature and weather conditions. Holding the deadman handle with your left hand; pull the engine starting rope with your right hand. After engine started, wait a sufficient time to let the engine warm up, then gradually release the choke to full open position and let the engine speed drops down to normal idle speed.

Adjust the blade angles (pitch) using the blade pitch control knob in the center of the handle. As soon as the trowel is ready for work, using the throttle lever slowly to rev-up the engine. As you speed up the engine, the clutch mechanism will automatically engage, and blades will start rotating.

5. CONTROL OF THE TROWEL MOTIONS

- Push the handle bar slightly downwards to move the trowel to the right.
- Lift the handle bar slightly upwards to move the trowel to the left.
- Push the handle bar straight forward to move the trowel in the forward direction.
- Pull the handle bar backwards to move the trowel in the backward direction.
- Holding the handle bar without exerting any force will keep the trowel in neutral position.

**** Always keep both of your hands on the handle bars for proper control of the machine! ****



6. STOPPING THE ENGINE

When you want to stop the engine, as a good practice, always keep holding the deadman handle, push the throttle lever forward to lower the engine speed to idle, until the blades stop completely, then you may release the deadman handle to stop the engine. Close the fuel valve. Turn the engine switch to “OFF” position.

In case of emergency, you may release the deadman switch to stop the engine immediately (Deadman handle not applicable in all U.S. Models. Please use centrifugal safety switch instead.)

7. FIRST TIME OPERATOR

We strongly recommend the first time operator to practice on a level dry ground first rather than starting to work immediately on fresh concrete. By practicing on a proper place, the operator can familiarize themselves with the machine and how to handle it. Once the operator feels confident, they may start working.

8. ROUGH CONCRETE SURFACE

The rough concrete surface must be leveled by using vibrators and screeds. This procedure will provide good compaction of the slab and produce a good surface for finishing.

**** Do not expect your trowel machine to remove the concrete surface irregularities or to repair the faulty concrete surface. ****



9. GENERAL USE

The timing for the floating and finishing operation is fully dependent on weather conditions, relative humidity and ambient temperature.

****DO NOT** leave the trowel while engine is still running on the fresh concrete, this may damage the concrete.

9.1 Floating Operation

While the engine is stopped, insert the floating blade (replace the existent blade with floating blade), adjust blade angles to full horizontal position, and get ready for the operation.

While the fresh concrete surface is drying, and the heel of shoes only leaves a 2-3 mm footprint, the concrete is ready for the floating operation.

When the footprint is barely visible on the concrete surface, the slab is ready for the finishing operation.

9.2 Finishing Operation

After the floating operation is finished, remove the floating blade and clean the concrete from the machine immediately. Replace (Insert) with the finish blade, adjust the blade angle for the first finishing operation, then perform the first finishing course. Increase the pitch of the blades and perform more finishing courses. In case some areas of the concrete are set /hardened too fast, you may use a hand brush to apply a small amount of water on that area. This will help to achieve better finishing operation. On those areas where water applied, be aware of the probability of trowel machine skating.

(See Appendix I)



10. CLEANING THE MACHINE

Keep your machine clean at all times. Clean it thoroughly at the end of each trowel session. Fresh cement can be easily removed with a hand brush and water. After cleaning and once the machine is dry, apply some stripping/coating oil to protect the blades and ring. This practice helps for smoother operation and easier cleaning for next operation.

11. TRANSPORTATION OF THE TROWEL

Prior to transporting the trowel machine, adjust the blades to full horizontal position.

**** DO NOT FORGET** to use a floating disc (pan) underneath the blades to protect the trowel arms. ******



12. OBTAINING BETTER PERFORMANCE AND RELIABILITY FOR YOUR MACHINE

Prior to each operation, perform visual inspection for maintenance issues such as:

- Check if the blades are bent or worn.
- Oil leakage.
- Tighten the loose part if any.
- Replace any worn, damaged parts. *Use only genuine replacement parts.*
- Lubricate.



13. ROUTINE CHECKS

DO NOT!!!

****Never exert any excess force to any part, control levers, knobs, or hand adjustments during any operation or maintenance.**

****Doing so may cause unnecessary damage to parts and the trowel machine. If any part is stuck or un-moveable, apply oil or appropriate lubricant then try to release the mechanism.**

****Do not force the levers beyond their normal limit of motion.**

****Never operate the machine without safety precautions.**

Routine Service Intervals		Each USE	After 1.5 months or 50 hrs	Every 3 months or 100 hrs	Every 6 months or 200 hrs	Every 9 months or 300 hrs	Every 12 months or 400 hrs
Guards	Check		o	o	o	o	o
Safety Decals	Check	o	o	o	o	o	o
Test Run:	Check Operation		o	o	o	o	o
Deadman switch	Check	o	o	o	o	o	o
Pitch Control	Check	o	o	o	o	o	o
	Lubricate		o	o	o	o	o
Engine Oil *1*	Check Level	o	o	o	o	o	o
	Change						
Engine Oil Filter *1*	Replace						
Oil Cooler	Clean			o	o	o	o
Cooling Fins	Clean		o	o	o	o	o
Air Cleaner	Check / Clean	o	o	o	o	o	o
	Replace						o
Air Intake Line	Check				o		
	Replace						2yrs
Fan Belt	Check Tightness				o		o
	Replace						500hrs
Valve Clearance	Check / Adjust				o		o
Fuel Filter	Check / Clean			o	o	o	o
	Replace				o		o
Fuel Tank	Check						500hrs
Engine/Machine Wiring	Check	o					o
Gearbox Oil *2*	Check Level	o	o	o	o	o	o
	Change			o			

Notes:

1.) See Engine manual for recommendation.

2.) Use MOBIL GLYGOYLE HE460 Gear oil or equal.

YOU CAN ALWAYS OBTAIN A BETTER RESULT WITH A WELL-MAINTAINED MACHINE



14. MACHINE PARTS REPLACEMENT

14.1 Changing Blades

- Prior to inserting the new blade, clean up all residual cement.
- Remove bolts and lock-washers of the blades to be replaced.
- Make certain that all the blades to be installed are perfectly flat.
- Insert the new blades to proper position. Check all bolts and lock-washers, replace them if necessary.
- Check and tighten bolts on blades if necessary. Verify the tightness of bolts after each operation.
- For a better performance of operation, replace all four blades simultaneously.

14.2 Changing V-Belts

- Prior changing the V-Belt, clean any residual concrete from the trowel.
- Loosen all of the bolts of the belt guard and remove them.
- Remove the existing V-Belt from the clutch pulleys.
- Replace the V-Belts with the identical size only.
- Make certain that V-Belts are uniformly seated in the clutch pulleys. If necessary , move the clutch pulleys for alignment.
- Remount the belt guard and tighten the bolts.

****NEVER operate the machine without the safety belt guard.**





14.3 Changing the Gearbox Oil

- Remove drainage bolt at the bottom of the gearbox, and drain the oil completely into a container.
- Contaminated oil must be disposed properly, according to any environmental laws and procedures.
- Clean the drainage bolt and tighten it into place.
- In order to have easy access for refilling, remove engine from the trowel machine (by removing 4 fasten bolts.)
- Remove oil air-bleed bolts from top of the gearbox.
- Fill only with manufacturer recommended gearbox oil (see Section 13 Routing Check) to the center of the sight gauge. (The gearbox has to be in a horizontal level during this process.)
- Refit the air-bleed bolt into its position and remount engine.

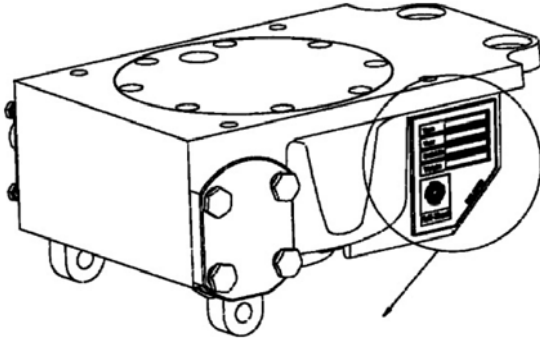

15. ORDERING SPARE PARTS



Type	FT 432 H
Year	2006
Serial No.	M5TC630071
Weight	80KG
 Full-Track	
BELGIUM	

Whenever ordering spare parts for your trowel machine, please indicate the following items in addition to the parts number of the parts to be ordered:

- ✓ Type of the Machine (Starting with FT...)
- ✓ Manufactured Year
- ✓ Serial Number (10 digital number)

All items mentioned above located at the identification plate on the side of the gearbox

**For engine spare parts,
please refer to the engine manual.**



16. TROUBLESHOOTING

Problem	Possible Cause	Remedy
1 Engine does not start	No fuel in the tank	Fill fuel
	Engine switch OFF	Switch it ON
	Deadman switch faulty	Replace switch
	Ignition problem	Service ignition system
	Engine fouling	Move lever to full throttle position, Bring choke to off position, wait for 10 minutes and try again
2 Hard to start the engine	Air filter clogged	Clean or replace air filter
	Spark plugs are worn or dirty	Replace spark plugs
	Ignition system problem	Service ignition system Dry the ignition system if damp
3 Engine running, but the clutch does not function properly or running slowly.	Broken V-Belt Slack V-Belt Faulty Clutch assembly	Install new V-Belt Adjust or replace V-Belt Service clutch assembly
4 Trowel does not work properly	Worn blades	Replace blades
5 Trowel leaves markings on concrete	Hardened cement slump on the blades Blade bent	Remove slumps and clean blades Replace blades
6 Trowel handle vibrating unevenly	Spider out of adjustment.	Adjust the spider precisely
7 Deadman switch inoperative	Micro switch broken	Replace micro switch
8 Any other questions		Contact your vendor!



17. TECHNICAL DATA

Model	FT-448
Overall Dimension	1800mm×1260mm×1030mm
Weight	110kg
Disc Diameter	1200mm
Number of Blades	4
Engine	9.0HP
Power	5.3KW@3600rpm
Engine Speed	3600rpm
Cooling	Air cooled
Starting	Manual start with pull rope-recoil starter
Blade Speed	30-200rpm **
Fuel Tank	6.0 liters / 9.0HP

**Notes: The Blade Speed may vary based on the Engine Option



APPENDIX I

FLOATING & FINISHING CONCRETE



FLOATING OPERATON

WALK-BEHIND/ RIDE-ON TROWEL MACHINE

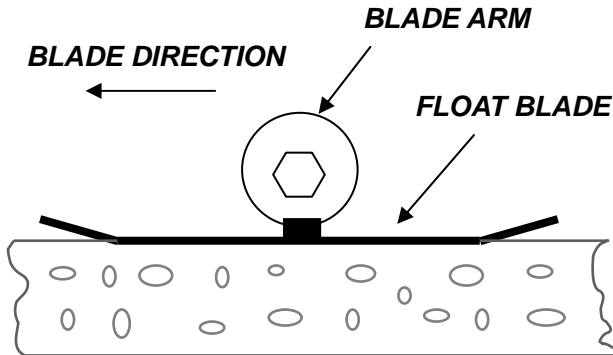

DURING THE FLOATING OPERATION, IT IS VERY IMPORTANT TO KEEP THE ANGLE OF THE BLADE VERY SLIGHT TO PREVENT CUTTING THE SURFACE.

INITIAL TROWELING (FINISHING) OPERATION

WALK-BEHIND/ RIDE-ON TROWEL MACHINE

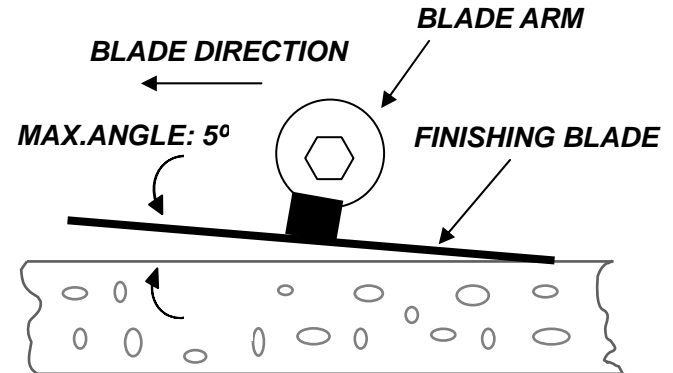

DURING THE INITIAL TROWELING (FINISHING) OPERATION, THE BLADE ANGLE SHOULD BE KEPT AT A MINIMUM TO PREVENT CUTTING THE CONCRETE SURFACE.



SUCCESSIVE TROWELING (FINISHING) OPERATIONS

WALK-BEHIND/ RIDE-ON TROWEL MACHINE

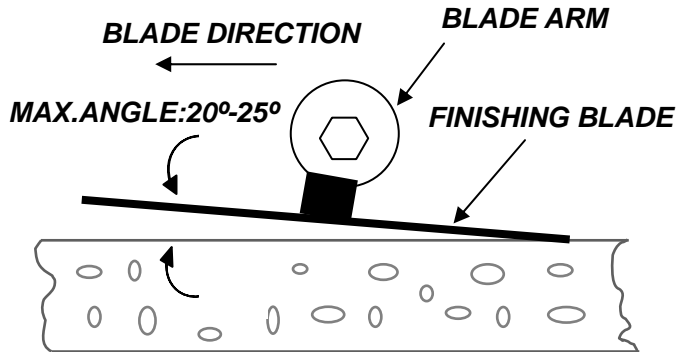

DURING ALL SUCCESSIVE FINISHING OPERATIONS, BLADE ANGLE CAN BE INCREASED SLIGHTLY, BUT TO A MAXIMUM NOT EXCEEDING ONE INCH (1.5CM) FROM CONCRETE SURFACE.

AS THE CONCRETE HARDENS, ADDITIONAL PRESSURE MIGHT BE REQUIRED TO SMOOTHEN THE CONCRETE SURFACE, THEREFORE THE PITCHING ANGLE OF THE BLADES NEED TO BE INCREASED.

RECOMMENDED POWER TROWEL MOVING DIRECTION

WALK-BEHIND/ RIDE-ON TROWEL MACHINE

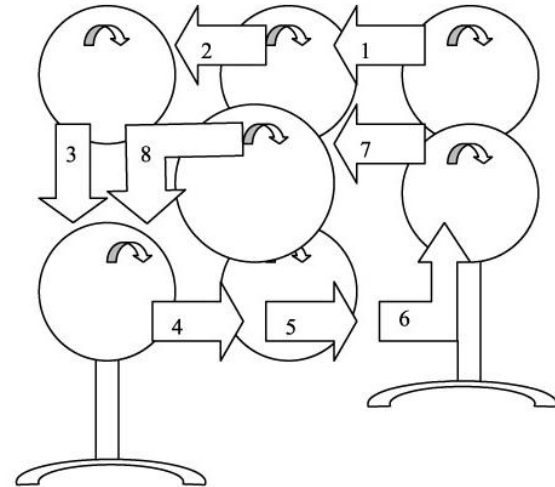

WORKING PERPENDICULAR TO PREVIOUS WORK PATH CAN PREVENT CREATION OF "VALLEYS" IN THE CONCRETE SLAB SURFACE.



**RECOMMENDED POWER
TROWEL MOVING DIRECTION**

WALK-BEHIND/ RIDE-ON TROWEL MACHINE

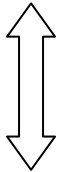

**DIRECTION OF
BULL FLOATING OPERATION**

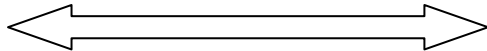

**DIRECTION OF
POWER FLOATING OPERATION**

**RECOMMENDED POWER
TROWEL MOVING DIRECTION**

WALK-BEHIND/ RIDE-ON TROWEL MACHINE

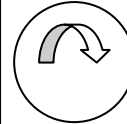

SECOND
TROWEL
FLOATING
PASS
DIRECTION
(PROBABLY
FINISHING)

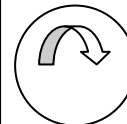

FIRST TROWEL
FLOATING PASS DIRECTION



WORKING PERPENDICULAR TO PREVIOUS
WORK PATH CAN PREVENT CREATION OF
"VALLEYS" IN THE CONCRETE SLAB
SURFACE.



FILLING A LOW AREA WITH A FULL-TRACK POWER TROWEL

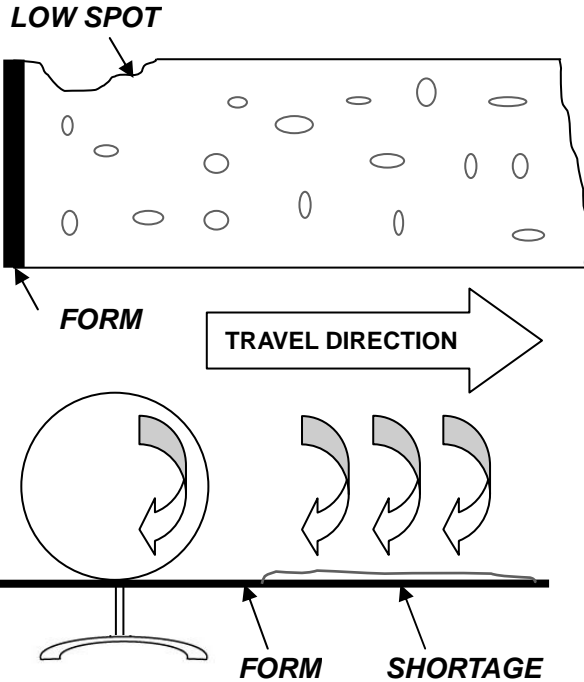

REMOVING EXCESS CONCRETE WITH A FULL-TRACK POWER TROWEL

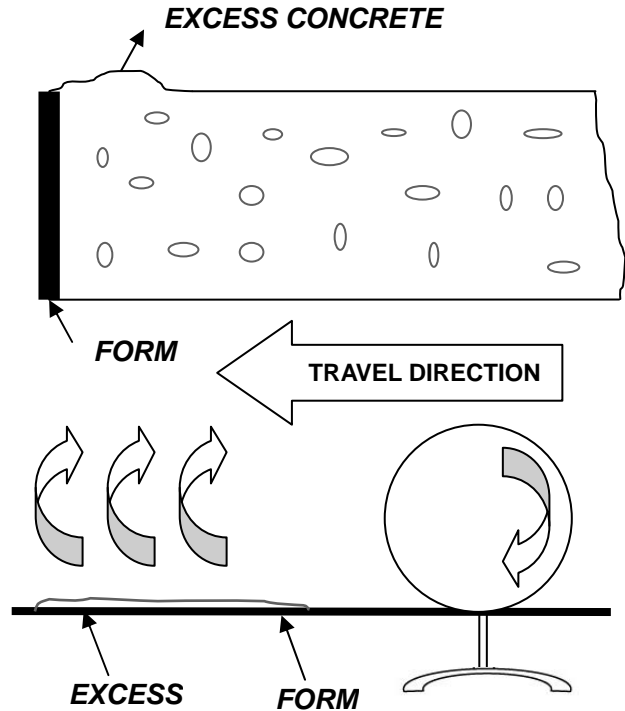

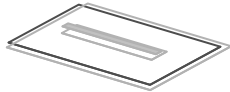

FLOATING BLADE

1. FLOATING BLADES:

These blades are 11.5'' (28cm) wide with all edges turned upward, so the blade won't penetrate or tear the fresh concrete. After the floating operation, they are removed and replaced by finishing or combination blades.

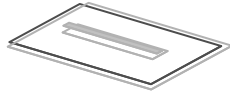

FINISHING BLADE

2. FINISHING BLADES:

These 7.5'' (18cm) wide blades are made of spring steel with a sharper edge in order to apply more pressures to densify the surface as the concrete hardens.

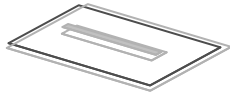

COMBO BLADE

3. COMBINATION BLADES:

Combination blades allow the same machine to be used for both floating and troweling in one operation without changing the blades. These blades are 7.87'' (20cm) wide with leading edge slightly turned upwards.

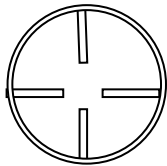

FLOATING DISC

4. FLOAT DISC (PAN)

These blades are used for the FT-432; FT-436 & FT-448 walk-behind trowel machines and the non-overlapping ride-on machines only.

They are secured under installed finishing blades; The outer edge is slightly turned upward. A disc (pan) can provide a larger contact surface area between concrete and trowel machine. So the operator can finish more square footage in the same period of time.



**WALK BEHIND TROWELING MACHINE
MOVING DIRECTION CONTROL**

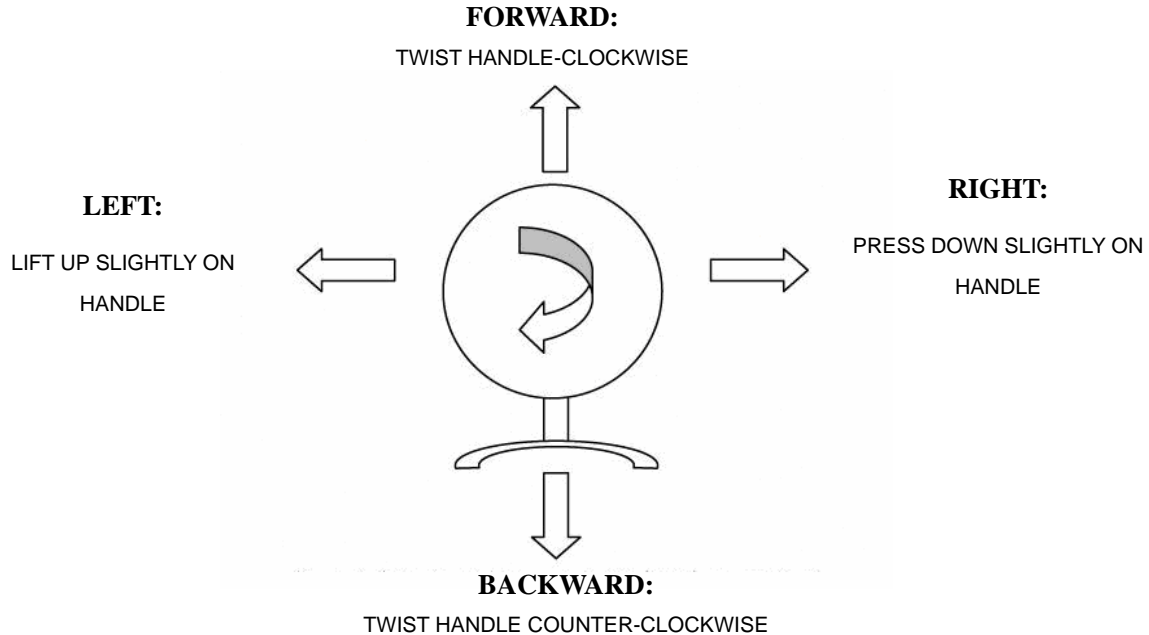

REMAIN ON ONE SPOT: HOLD HANDLE IN A NEUTRAL POSITION REPEATEDLY



Full-Track®
We'll put you right on track!!



Full-Track

EG-DECLARATION OF CONFORMITY FOR MACHINERY
Directive 89/392/EEC, Annex II, sub A

FULL-TRACK

Herewith declares that:

Concrete power trowel Full-Track 432 H – 436H – 448H

Are in compliance with the Machinery Directive (89/392/EEG, as amended, 91/368/EEG, 93/86/EEG);

Are in conformity with the provisions of the following other EEC directives: 86/336/EEG

18 January '05

B.Goossens
FULL-TRACK

For further information, please visit our website at:

<http://www.full-track.com>

<http://www.full-track.com.cn>

Or contact via e-mail:

info@full-track.com

info@full-track.com.cn

Update: July '07

WE'LL PUT YOU RIGHT ON TRACK!!!